



with Carefree's *Direct Response™* Auto-Retract System



Before operating the awning, carefully review the Owner's Manual. The manual contains important safety information, detailed operating instructions, common maintenance procedures and other useful information.



TABLE OF CONTENTS

Introduction	2
Operation	4
Description of Controls	5
Power Switch.....	5
Patio Switch.....	5
Motion Switch	5
Operating the Controls	6
Testing the Direct Response System	6
Using the Key FOB Remote Control.....	6
Key FOB Batteries.....	6
Programming the Remote Receiver	7
Operational Notes:	7
LED's	8
Adjusting the Pitch	9
Emergency Operation	10
Awning Care	11
Fabric Care.....	11
Arm Care.....	11
Carefree Major Product Limited Warranty	12

INTRODUCTION

Thank you for your recent purchase of the Eclipse awning. We appreciate having the opportunity to do business with you. Our customers are our top priority, and we strive for 100% satisfaction. If you have any questions or concerns about this order, please do not hesitate to contact us.

Check with your dealer to discover the products that can make your life more Carefree.

PRODUCT DESCRIPTION

The Eclipse awning provides motorized awning comfort with Carefree's standards for looks, strength and dependability with a successful blend of style, quality and economy.

- The unique "scissor" style arms do not require vertical ground supports.
- The adjustable arms provide easy to use 6-position pitch adjustment.
- The 100% billow-proof, worm-gear drive motor eliminates the need for travel locks.

Consult your Carefree Dealer for available options and upgrades.

This manual describes the operation and care for your Eclipse Patio Awning. Descriptions include: Single Switch Operation; and, the optional auto-retract system that closes the awning automatically in windy conditions.

DISCLAIMERS

The Eclipse awning and Direct Response auto-retract system are products of Carefree of Colorado, located in Broomfield, Colorado, USA. The information contained in or disclosed in this document is considered proprietary to Carefree of Colorado. Every effort has been made to ensure that the information presented in the document is accurate and complete. However, Carefree of Colorado assumes no liability for errors or for any damages that result from the use of this document.

The information contained in this manual pertains to the current product listed on the title page. Carefree of Colorado reserves the right to cancel, change, alter or add any parts and procedures, described in this manual, without prior notice.

Carefree of Colorado agrees to allow the reproduction of this document for use with Carefree of Colorado products only. Any other reproduction or translation of this document in whole or part is strictly prohibited without prior written approval from Carefree of Colorado.

SERVICE AND SUPPORT

	www.carefreeofcolorado.com/eclipse
	customerservice@carefreeofcolorado.com
	Carefree of Colorado 2145 W. 6th Ave. Broomfield, CO 80020

Warnings and Cautions



This is the safety alert symbol. It is used to alert individuals to potential personal injury hazards. Obey all safety messages that follow this symbol to avoid possible personal injury or death.



WARNING This product can expose you to chemicals including Diisodecyl phthalate (DIDP), Vinyl Chloride and Formaldehyde, which are known to the state of California to cause cancer or birth defects or other reproductive harm. For more information visit www.P65warnings.ca.gov



WARNING Risk of fire. Keep all sources of heat and flame away from the awning canopy. Fabric is NOT fireproof.

NOTICE

Awnings are designed to provide shade and protection from the sun. The effects of wind and rain on an awning are unpredictable and can cause severe damage to the awning and/or the vehicle. If wind or extended periods of rain are expected, roll up the awning.

NOTICE

It is recommended that if leaving the RV unattended for a length of time, retract the awning to avoid unexpected weather conditions.

NOTICE

If installed, LED lighting must be turned off when the awning is in the rolled up position. This is to prevent possible damage to the LEDs and/or canopy.

NOTICE

When the awning is in the retracted (rolled up) position, shut off the power switch to avoid accidentally extending the awning. For safety, the power switch must be turned off before moving the RV.

Additional Warnings and Cautions are included in the text for the proper operation of the awning.

Operational Notes:

Awning Motor: The awning motor is equipped with a thermal protection circuit to protect the motor from overheating. Operating the awning repeatedly over a short time period may cause the circuit to sense a overheat condition and shut off the motor. If this occurs, wait approximately 15 minutes to allow the motor to cool then operate the awning in normal fashion.

Ignition Lockout Sensors (Available with Direct Response Only): If the optional Carefree EL ignition lockout is installed the system will disable the extend function while the vehicle ignition key is in the ON position. Special order RTL ignition lockouts will fully retract the awning and disable the extend function when the vehicle ignition key is in the ON position. Functions will return to normal operation when the ignition key is turned OFF. RV manufacturers may install their own lockout design. Refer to the RV literature for 12V power used for accessories.

Carefree of Colorado

Special Note: This manual provides a basic description of the product and the standard operating controls provided by Carefree of Colorado. Some Original Equipment Manufacturers (OEM's) may alter or change the placement, style and/or functional configuration of the switches. If your controls do not match the style or description included, contact the coach manufacturer for an accurate description. OEM furnished components are not covered by the Carefree warranty.

OPERATION

The Auto-Retract System is an exciting enhancement to basic awning operation. When activated, the system will retract the awning in windy conditions. Sensitivity is set at the control panel.

The system uses a sensor in the motor head to detect awning motion caused by windy conditions. The system operates by gauging the vertical motion of the awning's leading edge. When persistent motion exceeds the factory preset threshold the system will retract the awning. The pushbutton controls allow the user to choose between 3 factory preset sensitivity values (threshold values).

NOTICE The Carefree Direct Response auto-retract system is a premiere electronic auto-retract system that provides protection against adverse elements; but, no auto-retract system is a guarantee against severe or destructive weather; the effects of wind and rain on an awning are unpredictable and may cause severe damage to the awning and/or vehicle. If wind or extended periods of rain are expected, retract the awning.

NOTICE The power switch must be set to OFF whenever the awning is not being operated and during transport. This acts as a safety to prevent the awning from being accidentally opened.

DESCRIPTION OF CONTROLS

The Eclipse Awning with Direct Response uses 3 switches at the control panel. Power Switch; Patio Switch and Motion Sensitivity Switch.

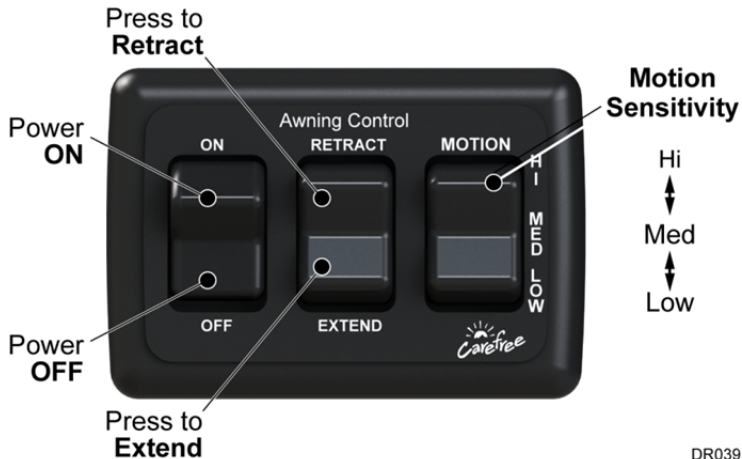

DR039

POWER SWITCH

POWER ON The top position activates the Patio switch and the Auto-Retract system and provides power to the awning.

POWER OFF The bottom position shuts the system down. The awning cannot be extended or retracted in this mode. The auto-retract system is also disabled.

IMPORTANT NOTE: The auto-retract system is ON when the power is ON. The system is OFF when the power switch is set to OFF. If the power is shut off while the awning is extended, the awning is not protected by the auto-retract system.

PATIO SWITCH

This is a two position momentary contact switch. This description also applies to any additional patio switches that may be installed.

EXTEND Press and release the switch. The awning automatically opens. To stop the awning before it is fully open, press and release the extend switch a second time.

RETRACT Press and release the switch. The awning automatically retracts until it is fully closed. To stop the awning before it is closed, press and release the retract switch a second time.

MOTION SWITCH

HIGH ↔ MED ↔ LOW

Low requires less amount of motion before the awning closes automatically. High requires more motion before the system closes automatically.

You may have to experiment to find the best setting for your preferences.

NOTE: If the motion switch is not installed, the system defaults to the medium setting.

OPERATING THE CONTROLS

- Turn the Power switch ON.
- Use the Patio switch to extend or retract the awning as desired.
- Set the Sensitivity switch to the level desired.

TESTING THE DIRECT RESPONSE SYSTEM

It is important to test the Direct Response system periodically to ensure that the system is working properly. Follow the simple test below.

1. Extend the awning completely.
2. Set the motion sensitivity to the lowest setting.
3. Gently move the roller tube up and down in a vertical motion.
4. If the awning retracts, the system is working properly.
5. If the awning does not retract, contact an authorized Carefree dealer for repairs. Operate the awning with the Patio switch until the system is repaired.

USING THE KEY FOB REMOTE CONTROL

A remote control Key FOB is available only with the auto-retract system. The remote provides the advantage of allowing you to operate the awning from any convenient location.

The remote has a maximum operating range of 50 feet. Actual distance may vary depending on the specific installation and location of the receiver in the vehicle.

To use: turn system power ON at the control panel.

NOTE: Power ON/OFF and the Auto-Retract system and can only be operated at the control panel.

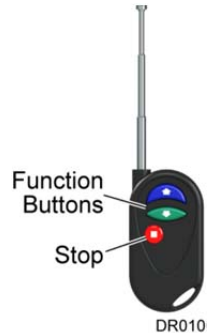

Extend__ Press and release. The awning will extend out to the full extension and stop automatically.

Retract__ Press and release. The awning will retract and stop automatically when the awning is fully retracted.

Stop..... Press and release. During extend and retract functions, the awning may be stopped by pressing this button.

KEY FOB BATTERIES

The Key FOB w/ antenna uses a battery (Radio Shack p/n 23-279 or equivalent) that should provide a long period of service. To access: Remove the small screw from the back of the case and carefully snap off the back. Lift the old battery out and insert the new battery.

Batteries are available through your local battery outlets.

Battery life is dependent on frequency of use, environmental conditions and condition of remote.

PROGRAMMING THE REMOTE RECEIVER

When adding or replacing a remote control, it is necessary to program the transmitter and receiver.

1. Awning power must be on.
2. Press and release the "Press to Learn Transmitter" button on the bottom of the receiver box. The receiver is in program mode when the red light comes on.
3. Press and release the STOP button on the remote. The red light will go out after the receiver learns the remote signal.

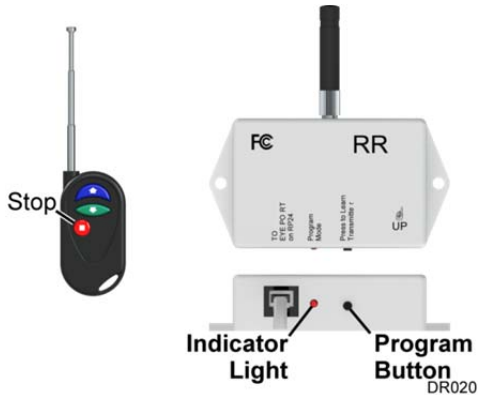

NOTE: Pressing the stop button will cause the blue up arrow button to default as the close (retract) function.

If a function button is pressed to train the receiver, it will be programmed as the retract button. Example: Pressing the top button will program the top button for retract and the bottom button as extend.

OPERATIONAL NOTES:

- Transmitter and receiver operate on frequency 433 MHz.
- The receiver exits the program mode after ten seconds.
- If the light does not come on, the memory is full and must be cleared.
- To clear the memory: **PRESS AND HOLD** the transmitter learn button. While holding the button, the indicator light should be OFF for the full 5 seconds then come on.
- If the light does not go out during programming, the receiver already knows the transmitter's signal or the battery in the remote needs to be replaced.
- The system may be programmed for up to 5 remotes. Additional remotes may be ordered separately.

LED'S

White (monotone) LEDs are a popular option providing lighting beneath the awning. Factory installed LEDs are located on the roller tube or can be mounted at the awning rail.

To operate the White LED lights, turn the LED power switch ON.

NOTE: Some OEMs may furnish their own switch that may appear differently than the switch pictured or may have the LED's operated through a multiplexing control center.



RGB (Color) LEDs

Select OEMs may offer RGB LEDs. These are NOT controlled through the BT12 Control System.

These lights use a separate IR (Infrared) remote and sensor. The top of the remote must be pointed at the infrared sensor on the LED receiver module.

The remote control provides:

- Simple push button on/off
- Adjustable dimming
- 15 color choices + white
- Special effects (flash, strobe, fade and smooth)

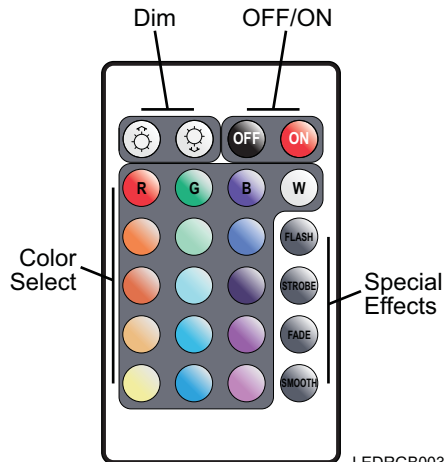

LEDRGB003

ADJUSTING THE PITCH

The Eclipse arms have 6 pitch adjustment settings from minimum pitch to maximum pitch. The awning can be extended and retracted in any of these positions without having to reset the pitch between uses. See the NOTICES at the bottom of the page.

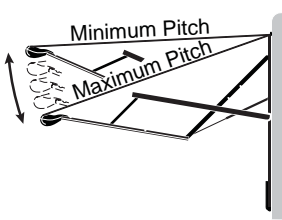

NOTE: The adjustment pins must engage in the holes to hold the pitch setting.

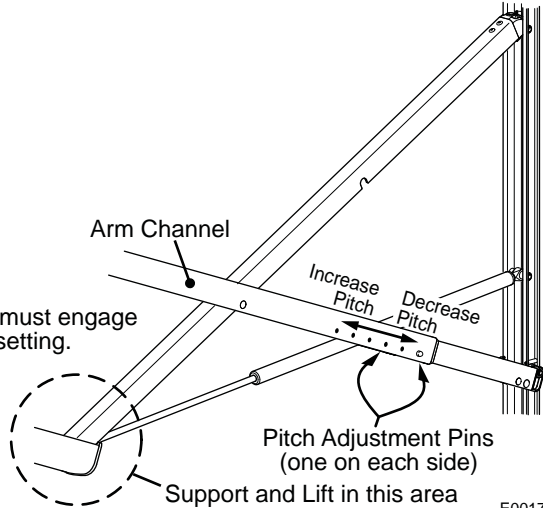

E0017

CAUTION Use care when adjusting the pitch as the awning may move abruptly.

1. Extend the awning completely. It is easier to adjust the pitch when the awning is fully extended.
2. Hold on to the awning arm to keep it steady while adjusting the pitch.
3. Press in the pitch adjustment pins, located on the long scissor arms.

Tip: Applying LIGHT pressure on the arm will decrease the force required to press the pitch adjustment pins.

4. Slide the outer scissor arm to the desired set of holes—towards the coach for a lower pitch and away from the coach for a higher pitch.

NOTICE For awnings under 12 feet long: Do not set the individual arm pitch at more than three (3) positions different between the left and right arm. Damage to the arms and canopy can occur if the awning is retracted when the arms are set at more than 3 positions difference.

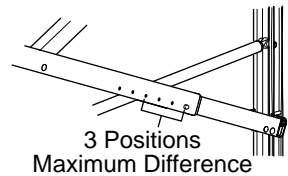

E0017b

EMERGENCY OPERATION

If the original power source fails or is unavailable, the Eclipse has emergency override terminals (12V). The terminals can be used with a 9V-18V power source, such as a cordless drill battery or car battery.

NOTICE Do not use a 110V power source for the emergency override procedure! Doing so will permanently damage the awning! Do not use the emergency override without following the directions below.

1. If there is an external plug, disconnect the plug, then go to step 3.
2. Awnings without an external plug:
 - 2.1 Remove the front cover from the motor head. There are six (6) small screws, do not remove the larger screw toward the center.
 - 2.2 Disconnect the input cable wires from the terminals. Do NOT disconnect the wires to the motor.
 - 2.3 Leave the wires disconnected and reattach the front cover.
3. Attach the provided jumper leads to the terminals, located on the rear of the motorized head.
4. Connect the other ends of the jumper leads to a 12V source. If the awning does not begin to move, reverse the leads.
5. Maintain contact throughout the retraction process.

CAUTION Use care when retracting the awning as the it may move abruptly.

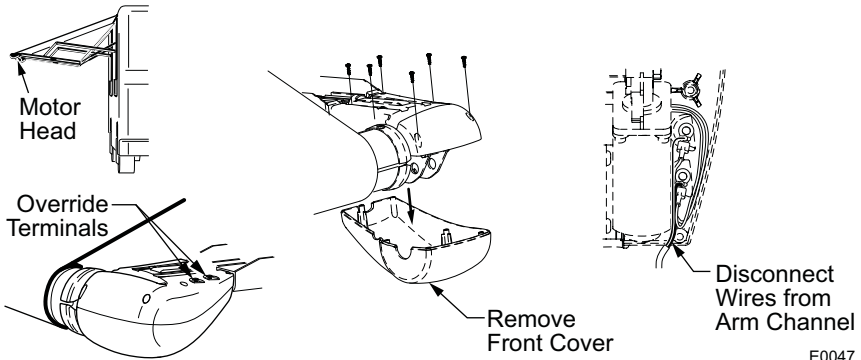

E0047

AWNING CARE

Maintaining a Carefree Awning is easy. Just follow these basic steps:

- Always operate the awning according to the instructions.
- Periodically check that the fasteners are tight. Tighten if necessary.
- Keep the awning fabric and arms clean.

FABRIC CARE

NOTICE Do not use oil based cleaners or any caustic, granulated, or abrasive type cleaners on your Carefree product.

1. One of the best ways to keep the fabric looking good and to delay the need for deep or vigorous cleanings is to hose fabrics off on a monthly basis with clear water. This practice will help prevent dirt from becoming deeply imbedded in the fabric. In most environments, a thorough cleaning will be needed every two to three years.
2. When it's time for a thorough cleaning, the fabric can be cleaned while still on the awning frame.
 - For Vinyl Fabric – Use a soft brush and warm water with soap.
 - For Acrylic Fabric – Use a stiff brush and warm water with soap.
3. When cleaning the fabric, it is important to observe the following:
 - Always use a natural soap, never detergent.
 - Water should be cold to lukewarm, never more than 100°F.
 - Air-dry only. Never apply heat to the fabric.
 - Always allow the fabric to dry thoroughly before rolling up the awning.

MILDEW

Mildew is a fungus growth that looks like dirt. Vinyl coated polyester fabrics are mildew resistant because of a chemical biocide in the vinyl coating. Under ordinary conditions, mildew will not appear. However, in areas where high temperature and humidity are common, mildew can be a problem and require the material to be washed more frequently. Thoroughly rinse the fabric with clean water and allow to air dry completely before rolling up the awning.

POOLING

When water collects on the top of the fabric, this is known as "pooling". This can occur during inclement weather or if a running air conditioner discharges over the awning. The water is dumped when the awning is retracted. It is recommended that if water accumulates on the top; retract the awning in steps (8"-12") to dump the water. This will help prevent the fabric from stretching or distorting.

LEAKING

On vinyl canopies, side hems and poly cords are stitched in with a sewing machine. On occasion, this stitching may allow water to seep or leak through the stitches. This is normal and not a defect covered by warranty. Treat the seams with a seam sealer.

ARM CARE

The best method of keeping the arms operating smoothly is to clean them. Dirt and debris can cause the channels not to slide easily. **Avoid introducing water into the motorized and non-motorized housings.**

Periodically wash out the channels with running water (i.e. a hose) to keep them clean. If the arms still do not slide easily, lightly spray the pivot and contact points with a dry silicone lubricant after the arms have been cleaned and dried thoroughly.

CAREFREE MAJOR PRODUCT LIMITED WARRANTY

Carefree of Colorado (hereafter referred to as Carefree) warrants to the first retail Purchaser that the Carefree Product is free of defects in material and workmanship within the terms and conditions as set forth in the warranty statement available online at www.carefreeofcolorado.com. Carefree's obligation under this warranty is limited to the repair or replacement, at Carefree's option, of any defective component with new or factory refurbished components.

OWNER MUST RETAIN THE ORIGINAL PROOF OF PURCHASE AND/OR HAVE THE PRODUCT WARRANTY REGISTRATION ON FILE AT CAREFREE FOR WARRANTY CLAIMS.

THIS WARRANTY IS NOT TRANSFERABLE.

Visit www.carefreeofcolorado.com for

- Warranty Duration;
- Warranty Coverage and Exclusions;
- Warranty Terms of Coverage; and,
- Warranty Claim Procedures

Register your Carefree products online at www.carefreeofcolorado.com



*Quality • Value
Performance • Style*

IMPORTANT NOTICE: It is strongly recommended that adjustments and repairs not described in this book be performed by trained technicians at your Authorized Carefree Dealer. Work performed by non-authorized persons or businesses may void warranty.