



ADJUSTABLE PITCH AND FIXED STEEP PITCH AWNINGS  
WITH *Direct Response*™

RV



*Before operating the awning, carefully review the Owner's Manual. The manual contains important safety information, detailed operating instructions, common maintenance procedures and other useful information.*



*TABLE OF CONTENTS*

<b>Introduction</b> .....	<b>2</b>
Common Operational Questions .....	3
<b>Operation</b> .....	<b>4</b>
LED's.....	5
<b>Adjusting the Pitch (Adjustable Pitch Awning Only)</b> .....	<b>6</b>
Emergency Operation .....	7
Override With Emergency Terminals.....	7
Override Without Emergency Terminals.....	8
Common Operational Questions .....	8
<b>Awning Care</b> .....	<b>9</b>
Fabric Care.....	9
Arm Care .....	9
<b>Carefree Major Product Limited Warranty</b> .....	<b>11</b>

INTRODUCTION

Thank you for your recent purchase of the Travel'r awning. We appreciate having the opportunity to do business with you. Our customers are our top priority, and we strive for 100% satisfaction. If you have any questions or concerns about this order, please do not hesitate to contact us.

Check with your dealer to discover the products that can make your life more Carefree.

*PRODUCT DESCRIPTION*

The Travel'r series of awnings provides motorized awning comfort with Carefree's standards for looks, strength and dependability.

*Features include:*

- The unique "scissor" style arms do not require vertical ground supports.
- The adjustable pitch arms provide easy to use 6-position pitch adjustment.
- The roller tube and arms are made from light weight, no-rust aluminum;
- The 100% billow-proof, worm-gear drive motor eliminates the need for travel locks.

*DISCLAIMERS*

The Eclipse awning is a product of Carefree of Colorado, located in Broomfield, Colorado, USA. The information contained in or disclosed in this document is considered proprietary to Carefree of Colorado. Every effort has been made to ensure that the information presented in the document is accurate and complete. However, Carefree of Colorado assumes no liability for errors or for any damages that result from the use of this document.

The information contained in this manual pertains to the current product listed on the title page. Carefree of Colorado reserves the right to cancel, change, alter or add any parts and procedures, described in this manual, without prior notice.

Carefree of Colorado agrees to allow the reproduction of this document for use with Carefree of Colorado products only. Any other reproduction or translation of this document in whole or part is strictly prohibited without prior written approval from Carefree of Colorado.

*SERVICE AND SUPPORT*

	<a href="http://www.carefreeofcolorado.com/eclipse">www.carefreeofcolorado.com/eclipse</a>
	<a href="mailto:customerservice@carefreeofcolorado.com">customerservice@carefreeofcolorado.com</a>
	<b>Carefree of Colorado</b> 2145 W. 6 <sup>th</sup> Ave. Broomfield, CO 80020

## Warnings and Cautions



This is the safety alert symbol. It is used to alert individuals to potential personal injury hazards. Obey all safety messages that follow this symbol to avoid possible personal injury or death.



**WARNING** This product can expose you to chemicals including Diisodecyl phthalate (DIDP), Vinyl Chloride and Formaldehyde, which are known to the state of California to cause cancer or birth defects or other reproductive harm. For more information visit [www.P65warnings.ca.gov](http://www.P65warnings.ca.gov)



**WARNING** Risk of fire. Keep all sources of heat and flame away from the awning canopy. Fabric is NOT fireproof.

### NOTICE

Awnings are designed to provide shade and protection from the sun. The effects of wind and rain on an awning are unpredictable and can cause severe damage to the awning and/or the vehicle. If wind or extended periods of rain are expected, roll up the awning.

### NOTICE

It is recommended that if leaving the RV unattended for a length of time, retract the awning to avoid unexpected weather conditions.

### NOTICE

If installed, LED lighting must be turned off when the awning is in the rolled up position. This is to prevent possible damage to the LEDs and/or canopy.

### NOTICE

When the awning is in the retracted (rolled up) position, shut off the power switch to avoid accidentally extending the awning. For safety, the power switch must be turned off before moving the RV.

Additional Warnings and Cautions are included in the text for the proper operation of the awning.

## COMMON OPERATIONAL QUESTIONS

The following items are operational items that may come up as questions during normal operation.

1. The awning motor is equipped with a thermal protection circuit to protect the motor from overheating. Operating the awning repeatedly over a short time period may cause the circuit to sense a overheat condition and shut off the motor. If this occurs, wait approximately 15 minutes to allow the motor to cool then operate the awning in normal fashion.
2. The awning seems to extend and retract slowly. Normal operation time is 28-35 seconds to extend or retract. If the power supply is on the low side of the acceptable voltage range (10VDC-14VDC) the awning will move slower.
3. The awning may appear to move jerkily. When the fabric is rolled out, the Alumaguard or Uniguard may "bounce" creating a wave like motion in the canopy fabric. This will create the appearance of moving jerkily.

If the awning does not operate, contact your Carefree Service Center. Visit our web site at [www.carefreeofcolorado.com](http://www.carefreeofcolorado.com) for a listing of dealers and service centers.

## Carefree of Colorado

Special Note: This manual provides a basic description of the product and the standard operating controls provided by Carefree of Colorado. Some Original Equipment Manufacturers (OEM's) may alter or change the placement, style and/or functional configuration of the switches. If your controls do not match the style or description included, contact the coach manufacturer for an accurate description. OEM furnished components are not covered by the Carefree warranty.

## OPERATION

**NOTICE** The Carefree auto retract system is a premier electronic auto-retract system that provides protection against adverse elements; but no auto-retract system is a guarantee against severe or destructive weather; the effects of wind and rain on an awning are unpredictable and may cause severe damage to the awning and/or vehicle. If wind or extended periods of rain are expected, roll up the awning.

The optional Travel'r *Direct Response*<sup>™</sup> system detects awning motion caused by windy conditions. The sensor is located in the motor head.

The system operates by gauging the motion of the awning's front edge (roller tube). When the motion exceeds the factory preset threshold value the system automatically retracts the awning.

Gust detection is incorporated into the software. When the motion value suddenly and sharply increases above a safe maximum value, the awning closes immediately.

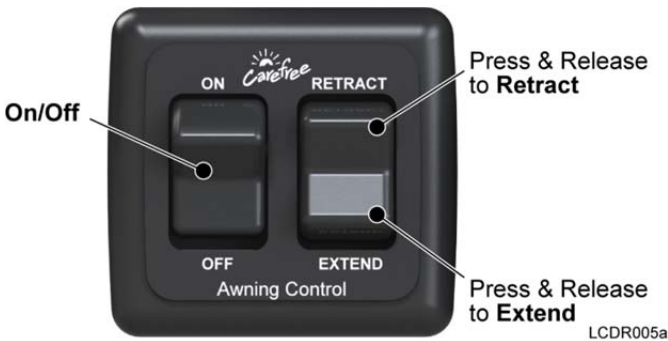

### To Operate the Awning:

- Press the power switch to ON. When power is on, the Direct Response system is active and the manual controls are active. When power is OFF, all functions are disabled.

**CAUTION** It is strongly recommended that the power switch be set to OFF during transport. This acts as a safety to prevent the awning from being accidentally opened.

- To OPEN the awning: Press and hold the extend switch until the awning is open.
- To CLOSE the awning: Press and release the retract switch. The awning will close completely. To interrupt the awning retraction, press and release the retract switch again. The awning will stop.
- When the awning is in the retracted (rolled up) position, shut off the power switch to avoid accidentally extending the awning.

*Want more controls? Ask your dealer about upgrading with Carefree's BT12 Wireless Awning Control System.*

## LED'S

White (monotone) LEDs are a popular option providing lighting beneath the awning. Factory installed LEDs are located on the roller tube or can be mounted at the awning rail.

To operate the White LED lights, turn the LED power switch ON.

**NOTE:** Some OEMS may furnish their own switch that may appear differently than the switch pictured or may have the LED's operated through a multiplexing control center.



## RGB (Color) LEDs

Select OEMs may offer RGB LEDs. These are NOT controlled through the BT12 Control System.

These lights use a separate IR (Infrared) remote and sensor. The top of the remote must be pointed at the infrared sensor on the LED receiver module.

The remote control provides:

- Simple push button on/off
- Adjustable dimming
- 15 color choices + white
- Special effects (flash, strobe, fade and smooth)

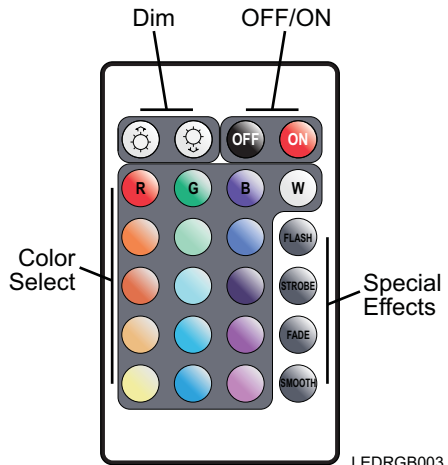

## ADJUSTING THE PITCH (ADJUSTABLE PITCH AWNING ONLY)

The Travel'r arms have 6 pitch adjustment settings from minimum pitch to maximum pitch. The awning can be extended and retracted in any of these positions without having to reset the pitch between uses. See the Warnings about unequal pitch settings.

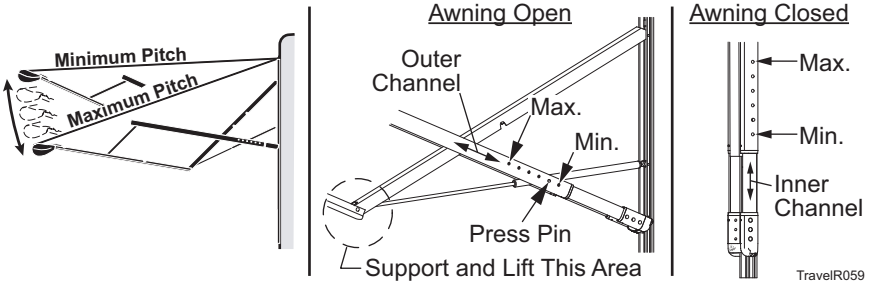

**CAUTION** Use care when adjusting the pitch as the awning may move abruptly.

### With the Awning Open:

1. Hold on to the awning arm to keep it steady while adjusting the pitch.
2. Press in the pitch adjustment pin located on the long scissor arm.

*Tip: Applying LIGHT pressure on the arm will decrease the force required to press the pitch adjustment pins.*

3. Slide the scissor arm to the desired set hole - towards the coach for a lower pitch and away from the coach for a higher pitch.

### With the Awning Closed:

1. Press in the pitch adjustment pin located on the long scissor arm.
2. Slide the inner scissor arm up or down to the desired set hole.

**NOTICE** Do not set the individual arm pitch at more than three (3) positions different between the left and right arm. Damage to the arms and canopy can occur if the awning is retracted when the arms are set at more than 3 positions difference.

**NOTICE** For awnings under 12': the arms must be set at an equal pitch. Damage to the arms and canopy can occur if the awning is retracted with the arms uneven.

## EMERGENCY OPERATION

If the original power source fails or is unavailable, the Travel'r has emergency override connections (12V). The override can be used with a 10V-14V power source, such as a cordless drill battery or car battery.

Travel'r models built through 2012 have override terminals on the back of the motor head. If the motor head has the metal terminals, use the procedure "Override with Emergency Terminals". For models built in 2013 and later, use "Override without Emergency Terminals".

**⚠ WARNING** Do not connect the Travel'r motor wires to a 110V power source! Doing so will permanently damage the awning!

**⚠ CAUTION** Use care when retracting the awning, the awning may move abruptly.

**NOTE:** Jumper cables may be built in one of two styles as shown below. The procedures are the same for either cable style.

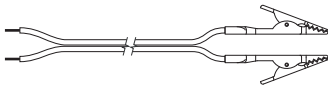

Universal Cable with Alligator Clips for External Emergency Terminals or Motor Cables with Quick Disconnects



Cables with Quick Disconnects for Motor Cables with Quick Disconnects Only

TravelR061b

## VERRIDE WITH EMERGENCY TERMINALS

**⚠ CAUTION** Do not use the emergency terminals without following the directions below. The electronic circuit creates a dynamic brake for the motor by shorting and grounding the motor leads. Steps 1 & 2 removes the brake to allow the emergency override to work.

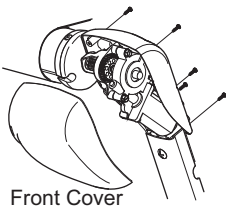

Front Cover  
**DETAIL A**

Disconnect Input Wires From Rear Cover

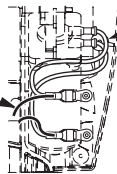

**DETAIL B**

DO NOT Disconnect Wires to Motor

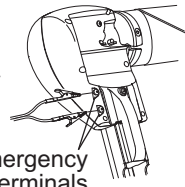

Emergency Terminals

**DETAIL C**

Travelr044a

1. (*Detail A*) Remove the front cover from the motor head. There are six (6) small screws in the rear of the motor head.
2. (*Detail B*) Disconnect the input cable wires from the terminals. Do NOT disconnect the wires to the motor.
3. Leave the wires disconnected and reattach the front cover.
4. (*Detail C*) Attach jumper leads to the terminals, located on the rear of the motorized head.
5. Connect the other ends of the jumper leads to a 12V source. If the awning moves in the wrong direction, reverse the leads.
6. Maintain contact throughout the retraction process.

### OVERRIDE WITHOUT EMERGENCY TERMINALS

This procedure does not apply if Direct Response is installed.

1. Locate and separate the quick disconnects located in the motor arm channel. Position the wires from the motor on the outside of the channel.
2. Attach jumper wires to the motor wires.
3. Connect the other ends of the jumper leads to a 12-14V source. If the awning moves in the wrong direction, reverse the leads.
4. Maintain contact throughout the retraction process. Hold the wires from the motor on the outside of the channel while closing the awning. This provides access for opening awning.
5. When power is restored, use the jumper wires and extend the awning to access the cable disconnects. Reattach the disconnects and secure in the arm channel.

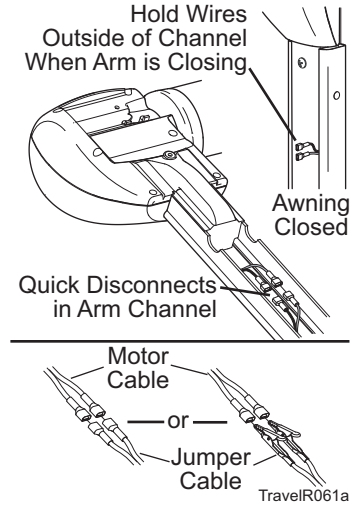

**NOTE:** Jumper cables may not be included with some OEM installations. Cables are available through your dealer

### COMMON OPERATIONAL QUESTIONS

The following items are operational items that may come up as questions during normal operation.

1. The awning motor is equipped with a thermal protection circuit to protect the motor from overheating. Operating the awning repeatedly over a short time period may cause the circuit to sense a overheat condition and shut off the motor. If this occurs, wait approximately 15 minutes to allow the motor to cool then operate the awning in normal fashion.
4. The awning seems to extend and retract slowly. Normal operation time is 28-35 seconds to extend or retract. If the power supply is on the low side of the acceptable voltage range (10VDC-14VDC) the awning will move slower.
5. The awning may appear to move jerkily. When the fabric is rolled out, the Alumaguard or Uniguard may "bounce" creating a wave like motion in the canopy fabric. This will create the appearance of moving jerkily.
6. With Uniguard, the awning sticks or hangs up. When Uniguard is installed with a vinyl canopy, the vinyl will have a tendency to "cling" to the Uniguard when not used over an extended period. Open and close the awning in short bursts 2 or 3 times, the awning will then open normally.

If the awning does not operate, contact your Carefree Service Center. Visit our web site at [www.carefreeofcolorado.com](http://www.carefreeofcolorado.com) for a listing of dealers and service centers.



## AWNING CARE

Maintaining a Carefree Awning is easy. Just follow these basic steps:

- Always operate the awning according to the instructions.
- Periodically check that the fasteners are tight. Tighten if necessary.
- Keep the awning fabric and arms clean.

### *FABRIC CARE*

**NOTICE** **DO not use oil based cleaners or any caustic, granulated, or abrasive type cleaners on your Carefree product.**

1. One of the best ways to keep the fabric looking good and to delay the need for deep or vigorous cleanings is to hose fabrics off on a monthly basis with clear water. This practice helps prevent dirt from becoming deeply imbedded in the fabric. In most environments, a thorough cleaning will be needed every two to three years.
2. When it's time for a thorough cleaning, the fabric can be cleaned while still on the awning frame.
  - For Vinyl Fabric – Use a soft brush and warm water with soap.
  - For Acrylic Fabric – Use a stiff brush and warm water with soap.
3. When cleaning the fabric, it is important to observe the following:
  - Always use a natural soap, never detergent.
  - Water should be cold to lukewarm, never more than 100°F.
  - Air-dry only. Never apply heat to the fabric.
  - Always allow the fabric to dry thoroughly before rolling up the awning.

### *MILDEW*

Mildew is a fungus growth that looks like dirt. Vinyl coated polyester fabrics are mildew resistant because of a chemical biocide in the vinyl coating. Under ordinary conditions, mildew will not appear. However, in areas where high temperature and humidity are common, mildew can be a problem and require the material to be washed more frequently.

### *POOLING*

When water collects on the top of the fabric, this is known as "pooling". This can occur during inclement weather or if a running air conditioner discharges over the awning. The water is dumped when the awning is retracted. It is recommended that if water accumulates on the top; retract the awning in steps (8"-12") to dump the water. This will help prevent the fabric from stretching or distorting.

**The effects of wind and rain on an awning are unpredictable. Severe damage to the awning and the vehicle may result. IF WIND OR EXTENDED PERIODS OF RAIN ARE EXPECTED, ROLL UP THE AWNING AND SECURE FOR TRAVEL.**

### *LEAKING*

On vinyl canopies, side hems and poly cords are stitched in with a sewing machine. On occasion, this stitching may allow water to seep or leak through. This is normal and not a defect covered by warranty. Treat the seams with a quality seam sealer.

### *ARM CARE*

The best method of keeping the arms and braces operating smoothly is to clean them. Dirt and debris can cause the arms not to move easily. Periodically wash out the channels with running water (i.e. a hose). If the arms still do not move easily, lightly spray the joints and pivot points with a dry silicone lubricant after the arms have been cleaned and dried thoroughly.



## CAREFREE MAJOR PRODUCT LIMITED WARRANTY

Carefree of Colorado (hereafter referred to as Carefree) warrants to the first retail Purchaser that the Carefree Product is free of defects in material and workmanship within the terms and conditions as set forth in the warranty statement available online at [www.carefreeofcolorado.com](http://www.carefreeofcolorado.com). Carefree's obligation under this warranty is limited to the repair or replacement, at Carefree's option, of any defective component with new or factory refurbished components.

OWNER MUST RETAIN THE ORIGINAL PROOF OF PURCHASE AND/OR HAVE THE PRODUCT WARRANTY REGISTRATION ON FILE AT CAREFREE FOR WARRANTY CLAIMS.

THIS WARRANTY IS NOT TRANSFERABLE.

Visit [www.carefreeofcolorado.com](http://www.carefreeofcolorado.com) for

- **Warranty Duration;**
- **Warranty Coverage and Exclusions;**
- **Warranty Terms of Coverage; and,**
- **Warranty Claim Procedures**

*Register your Carefree products online at [www.carefreeofcolorado.com](http://www.carefreeofcolorado.com)*

**IMPORTANT NOTICE:** It is strongly recommended that adjustments and repairs not described in this book be performed by trained technicians at your Authorized Carefree Dealer. Work performed by non-authorized persons or businesses may void warranty.

